

CKT. SIZE	DIM. "A"		DIM. "B"	
	MM	IN.	MM	IN.
2	2.54	.100	5.33	.210
3	5.08	.200	8.13	.320
4	7.62	.300	10.67	.420
5	10.16	.400	13.21	.520
6	12.70	.500	15.75	.620
7	15.24	.600	18.29	.720
8	17.78	.700	20.83	.820
9	20.32	.800	23.37	.920
10	22.86	.900	25.91	1.020
11	25.40	1.000	28.45	1.120
12	27.94	1.100	30.99	1.220
13	30.48	1.200	33.53	1.320
14	33.02	1.300	36.07	1.420
15	35.56	1.400	38.61	1.520
16	38.10	1.500	41.15	1.620
17	40.64	1.600	43.69	1.720
18	43.18	1.700	46.23	1.820
19	45.72	1.800	48.77	1.920
20	48.26	1.900	51.31	2.020
21	50.80	2.000	53.85	2.120
22	53.34	2.100	56.39	2.220
23	55.88	2.200	58.93	2.320
24	58.42	2.300	61.47	2.420
25	60.96	2.400	64.01	2.520

- NOTES:
- HEADER MATERIAL: GLASS FILLED POLYESTER, UL 94V-0, COLOR: BLACK
PIN MATERIAL: PHOSPHOR BRONZE
 - FINISH:
TIN: 3.81 MICROMETERS/150 MICROINCHES MINIMUM TIN PLATE OVERALL
OVER NICKEL UNDERPLATE OVERALL
15 GOLD: 0.38 MICROMETERS/15 MICROINCHES MINIMUM GOLD PLATE IN CONTACT AREA
1.91 MICROMETERS/75 MICROINCHES MINIMUM TIN PLATE IN TAIL AREA
OVER NICKEL UNDERPLATE OVERALL
30 GOLD: 0.76 MICROMETERS/30 MICROINCHES MINIMUM GOLD PLATE IN CONTACT AREA
1.91 MICROMETERS/75 MICROINCHES MINIMUM TIN PLATE IN TAIL AREA
OVER NICKEL UNDERPLATE OVERALL
 - HEADER TO BE USED WITH OPTION "G" 70400 AND 70430 SERIES SL CONNECTORS
 - REFER TO MOLEX PRODUCT SPECIFICATION PS-70541 & PS-70400
 - STANDARD PACKAGING IN TUBES PER PK-70873-0015 OR OPTIONAL PACKAGING IN BAGS PER PK-70873-0535. OPTION PACK NOT AVAILABLE FOR ALL CKT SIZES.
 - DIMENSIONS WITHOUT TOLERANCE ARE SHOWN FOR REFERENCE ONLY.
 - MEASURE POINT FOR PLATING THICKNESS
 - ALTERNATIVE RIB, MAY BE SPLIT OR CONTINUOUS. EITHER OPTION DOES NOT IMPACT FUNCTION OF THE ASSEMBLY.

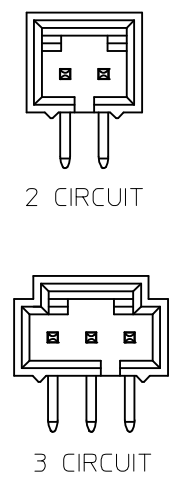
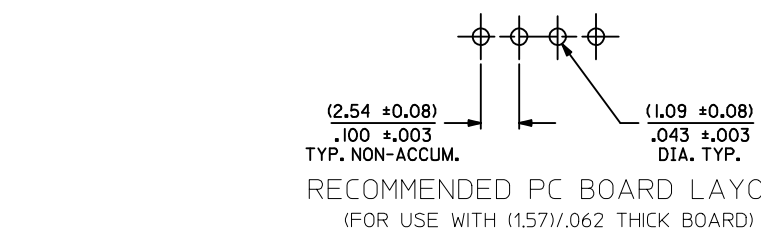

ADD RIB NOTE 8 EC NO: UCP2010-0787 DRWINHIS BARRA 2009/09/24 CHKD:DMORGAN 2009/10/02 APPR:SMILLER 2009/10/05	QUALITY SYMBOLS ▽=0 ▽=0 ▽=0	GENERAL TOLERANCES (UNLESS SPECIFIED)		DIMENSION STYLE MM/IN		SCALE 4:1	DESIGN UNITS INCH	THIRD ANGLE PROJECTION
		4 PLACES ± --- ± ---	3 PLACES ± --- ± .005	DRAWN BY AAB	DATE 1993/05/13	TITLE SALES ASSY, SL RIGHT ANGLE HDR W/LATCH (2.54)/.100 CENTERS		
		2 PLACES ± 0.13 ± .010	1 PLACE ± 0.25 ± ---	CHECKED BY AAB	DATE 1993/05/13	MOLEX INCORPORATED		
		ANGULAR ±1/2°		APPROVED BY WAZ	DATE 1993/05/13	MOLEX INCORPORATED		
DRAFT WHERE APPLICABLE MUST REMAIN WITHIN DIMENSIONS		MATERIAL NO. SEE TABLE		DOCUMENT NO. SDA-70553-****		SHEET NO. 1 OF 3		
THIS DRAWING CONTAINS INFORMATION THAT IS PROPRIETARY TO MOLEX INCORPORATED AND SHOULD NOT BE USED WITHOUT WRITTEN PERMISSION								

J	CIRCUIT SIZE	ENGINEERING NUMBER A-70553	MANUFACTURE RELEASE STATUS					D REF.	E ± .010	PLATING TYPE	CONNECTOR END PLATING			P.C. BOARD END PLATING			SEE PACK INFORMA. DRAWING PK-70873
											TYPE	H MEAS.		TYPE	K MEAS.		
	2-10	-0001-0009	R.F.M.					(3.30) .130	(6.10) .240	15 GOLD	GOLD	(2.54) .100		TIN	(1.27) .050		-0015 (TUBES)
	11-25	-0010-0024	R.F.M.														
I	2-10	-0036-0044	R.F.M.					(3.30) .130	(6.10) .240	TIN	TIN	(2.54) .100		TIN	(1.27) .050		-0015 (TUBES)
	11-25	-0045-0059	R.F.M.														
	2-10	-0106-0114	R.F.M.					(3.30) .130	(6.10) .240	30 GOLD	GOLD	(2.54) .100		TIN	(1.27) .050		-0015 (TUBES)
	11-25	-0115-0129	R.F.M.														
H	2-10	-0141-0149	R.F.M.					(2.67) .105	(6.10) .240	15 GOLD	GOLD	(2.54) .100		TIN	(1.27) .050		-0015 (TUBES)
	11-25	-0150-0159	R.F.M.														
	2-10																
G	11-25																

CIRCUIT SIZE	ASSEMBLY ITEM NUMBER	ASSEMBLY ITEM NUMBER	ASSEMBLY ITEM NUMBER	ASSEMBLY ITEM NUMBER	ASSEMBLY ITEM NUMBER	ASSEMBLY ITEM NUMBER
2	70553-0001	70553-0036	70553-0106	70553-0141		
3	70553-0002	70553-0037	70553-0107	70553-0142		
4	70553-0003	70553-0038	70553-0108	70553-0143		
5	70553-0004	70553-0039	70553-0109	70553-0144		
6	70553-0005	70553-0040	70553-0110	70553-0145		
7	70553-0006	70553-0041	70553-0111	70553-0146		
8	70553-0007	70553-0042	70553-0112	70553-0147		
9	70553-0008	70553-0043	70553-0113	70553-0148		
10	70553-0009	70553-0044	70553-0114	70553-0149		
11	70553-0010	70553-0045	70553-0115	70553-0150		
12	70553-0011	70553-0046	70553-0116	70553-0151		
13	70553-0012	70553-0047	70553-0117	70553-0152		
14	70553-0013	70553-0048	70553-0118	70553-0153		
15	70553-0014	70553-0049	70553-0119	70553-0154		
16	70553-0015	70553-0050	70553-0120	70553-0155		
17	70553-0016	70553-0051	70553-0121	70553-0156		
18	70553-0017	70553-0052	70553-0122	70553-0157		
19	70553-0018	70553-0053	70553-0123	70553-0158		
20	70553-0019	70553-0054	70553-0124	70553-0159		
21	70553-0020	70553-0055	70553-0125	70553-0160		
22	70553-0021	70553-0056	70553-0126	70553-0161		
23	70553-0022	70553-0057	70553-0127	70553-0162		
24	70553-0023	70553-0058	70553-0128	70553-0163		
25	70553-0024	70553-0059	70553-0129	70553-0164		

X IN COLUMN UNDER *ASSEMBLY ITEM NUMBER * HEADING DENOTES TOOLING NOT AVAILABLE

A	UPDATE REV LEVEL EC NO: UCP2010-0787 DRWINSI BARRA 2009/09/24 CHKD:MORGAN 2009/10/02 APPR:SMILLER 2009/10/05	QUALITY SYMBOLS 	GENERAL TOLERANCES (UNLESS SPECIFIED)		DIMENSION STYLE MM/IN		SCALE 4:1	DESIGN UNITS INCH	THIRD ANGLE PROJECTION
					DRAWN BY DATE AAB 1993/05/13		TITLE SALES ASSY, SL RIGHT ANGLE HDR W/LATCH (2.54)/.100 CENTERS		
					CHECKED BY DATE AAB 1993/05/13		APPROVED BY DATE WAZ 1993/05/13		
					MATERIAL NO. SEE TABLE		DOCUMENT NO. SDA-70553-****		
		DRAFT WHERE APPLICABLE MUST REMAIN WITHIN DIMENSIONS		SIZE C		THIS DRAWING CONTAINS INFORMATION THAT IS PROPRIETARY TO MOLEX INCORPORATED AND SHOULD NOT BE USED WITHOUT WRITTEN PERMISSION		SHEET NO. 2 OF 3	

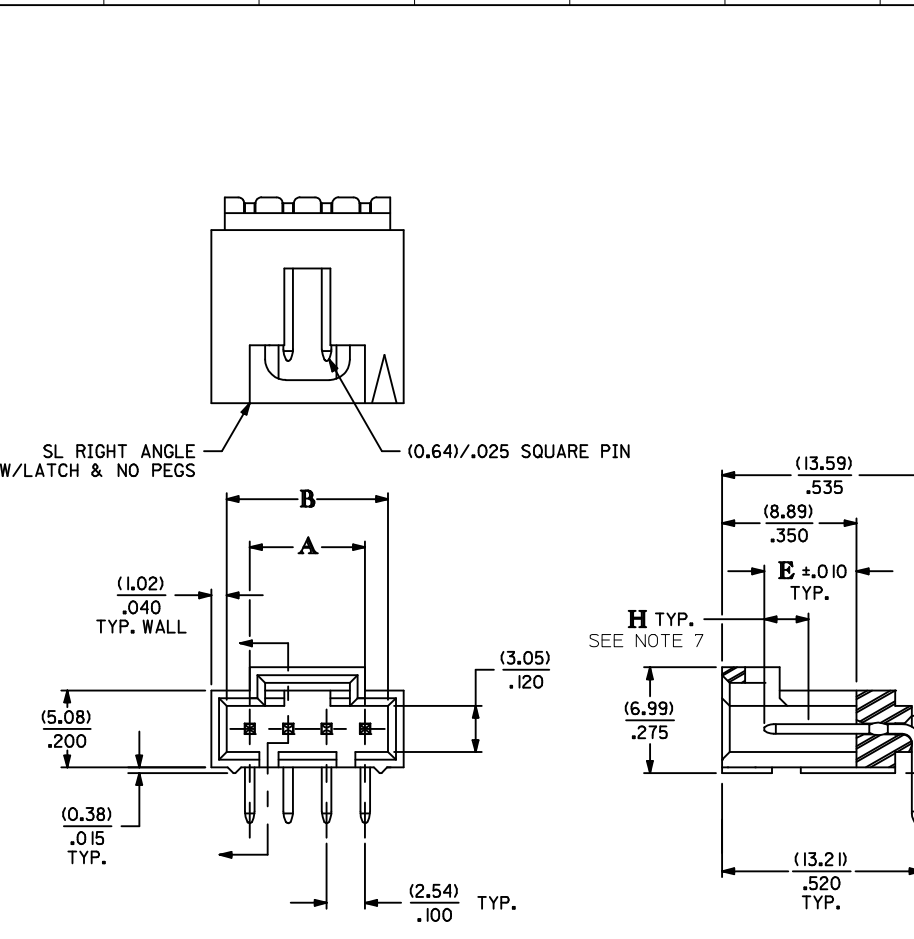

SL RIGHT ANGLE W/LATCH & NO PEGS (0.64)/.025 SQUARE PIN

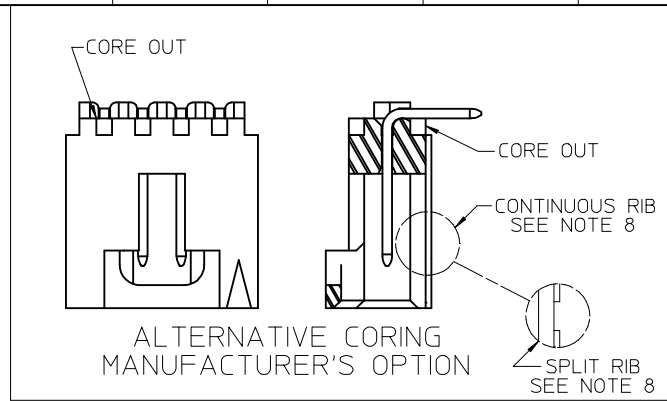

ALTERNATIVE CORING MANUFACTURER'S OPTION

CKT. SIZE	DIM. "A"		DIM. "B"	
	MM	IN.	MM	IN.
2	2.54	.100	5.33	.210
3	5.08	.200	8.13	.320
4	7.62	.300	10.67	.420
5	10.16	.400	13.21	.520
6	12.70	.500	15.75	.620
7	15.24	.600	18.29	.720
8	17.78	.700	20.83	.820
9	20.32	.800	23.37	.920
10	22.86	.900	25.91	1.020
11	25.40	1.000	28.45	1.120
12	27.94	1.100	30.99	1.220
13	30.48	1.200	33.53	1.320
14	33.02	1.300	36.07	1.420
15	35.56	1.400	38.61	1.520
16	38.10	1.500	41.15	1.620
17	40.64	1.600	43.69	1.720
18	43.18	1.700	46.23	1.820
19	45.72	1.800	48.77	1.920
20	48.26	1.900	51.31	2.020
21	50.80	2.000	53.85	2.120
22	53.34	2.100	56.39	2.220
23	55.88	2.200	58.93	2.320
24	58.42	2.300	61.47	2.420
25	60.96	2.400	64.01	2.520

- NOTES:
- HEADER MATERIAL: GLASS FILLED POLYESTER, UL 94V-0, COLOR: BLACK
PIN MATERIAL: PHOSPHOR BRONZE
 - FINISH:
TIN: 3.81 MICROMETERS/150 MICROINCHES MINIMUM TIN PLATE OVERALL
OVER NICKEL UNDERPLATE OVERALL
15 GOLD: 0.38 MICROMETERS/15 MICROINCHES MINIMUM GOLD PLATE IN CONTACT AREA
1.91 MICROMETERS/75 MICROINCHES MINIMUM TIN PLATE IN TAIL AREA
OVER NICKEL UNDERPLATE OVERALL
30 GOLD: 0.76 MICROMETERS/30 MICROINCHES MINIMUM GOLD PLATE IN CONTACT AREA
1.91 MICROMETERS/75 MICROINCHES MINIMUM TIN PLATE IN TAIL AREA
OVER NICKEL UNDERPLATE OVERALL
 - HEADER TO BE USED WITH OPTION "G" 70400 AND 70430 SERIES SL CONNECTORS
 - REFER TO MOLEX PRODUCT SPECIFICATION PS-70541 & PS-70400
 - STANDARD PACKAGING IN TUBES PER PK-70873-0015 OR OPTIONAL PACKAGING IN BAGS PER PK-70873-0535. OPTION PACK NOT AVAILABLE FOR ALL CKT SIZES.
 - DIMENSIONS WITHOUT TOLERANCE ARE SHOWN FOR REFERENCE ONLY.
 - MEASURE POINT FOR PLATING THICKNESS
 - ALTERNATIVE RIB, MAY BE SPLIT OR CONTINUOUS. EITHER OPTION DOES NOT IMPACT FUNCTION OF THE ASSEMBLY.

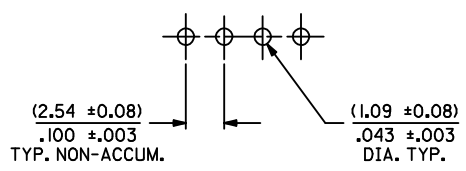

RECOMMENDED PC BOARD LAYOUT
(FOR USE WITH (1.57)/.062 THICK BOARD)

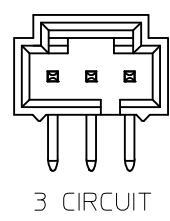
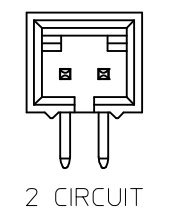

ADD RIB NOTE 8 EC NO: UCP2010-0787 DRWINHIS BARRA 2009/09/24 CHKD:MORGAN 2009/10/02 APPR:SMILLER 2009/10/05	QUALITY SYMBOLS ▽=0 ▽=0 ▽=0	GENERAL TOLERANCES (UNLESS SPECIFIED)		DIMENSION STYLE MM/IN		SCALE 4:1	DESIGN UNITS INCH	THIRD ANGLE PROJECTION
		4 PLACES ± --- ± ---	3 PLACES ± --- ± .005	DRAWN BY AAB	DATE 1993/05/13	TITLE SALES ASSY, SL RIGHT ANGLE HDR W/LATCH (2.54)/.100 CENTERS		
		2 PLACES ± 0.13 ± .010	1 PLACE ± 0.25 ± ---	CHECKED BY AAB	DATE 1993/05/13	MOLEX INCORPORATED		
		ANGULAR ±1/2°		APPROVED BY WAZ	DATE 1993/05/13	MOLEX INCORPORATED		
DRAFT WHERE APPLICABLE MUST REMAIN WITHIN DIMENSIONS		MATERIAL NO. SEE TABLE		DOCUMENT NO. SDA-70553-****		SHEET NO. 1 OF 3		
THIS DRAWING CONTAINS INFORMATION THAT IS PROPRIETARY TO MOLEX INCORPORATED AND SHOULD NOT BE USED WITHOUT WRITTEN PERMISSION								

J	CIRCUIT SIZE	ENGINEERING NUMBER A-70553	MANUFACTURE RELEASE STATUS					D REF.	E ± .010	PLATING TYPE	CONNECTOR END PLATING			P.C. BOARD END PLATING			SEE PACK INFORMA. DRAWING PK-70873
											TYPE	H MEAS.		TYPE	K MEAS.		
	2-10	-0001-0009	R.F.M.					(3.30) .130	(6.10) .240	15 GOLD	GOLD	(2.54) .100		TIN	(1.27) .050		-0015 (TUBES)
	11-25	-0010-0024	R.F.M.					(3.30) .130	(6.10) .240	TIN	TIN	(2.54) .100		TIN	(1.27) .050		-0015 (TUBES)
	2-10	-0036-0044	R.F.M.					(3.30) .130	(6.10) .240	30 GOLD	GOLD	(2.54) .100		TIN	(1.27) .050		-0015 (TUBES)
	11-25	-0045-0059	R.F.M.					(2.67) .105	(6.10) .240	15 GOLD	GOLD	(2.54) .100		TIN	(1.27) .050		-0015 (TUBES)
	2-10	-0106-0114	R.F.M.														
	11-25	-0115-0129	R.F.M.														
	2-10	-0141-0149	R.F.M.														
	11-25	-0150-0159	R.F.M.														
	2-10																
	11-25																

CIRCUIT SIZE	ASSEMBLY ITEM NUMBER	ASSEMBLY ITEM NUMBER	ASSEMBLY ITEM NUMBER	ASSEMBLY ITEM NUMBER	ASSEMBLY ITEM NUMBER	ASSEMBLY ITEM NUMBER
2	70553-0001	70553-0036	70553-0106	70553-0141		
3	70553-0002	70553-0037	70553-0107	70553-0142		
4	70553-0003	70553-0038	70553-0108	70553-0143		
5	70553-0004	70553-0039	70553-0109	70553-0144		
6	70553-0005	70553-0040	70553-0110	70553-0145		
7	70553-0006	70553-0041	70553-0111	70553-0146		
8	70553-0007	70553-0042	70553-0112	70553-0147		
9	70553-0008	70553-0043	70553-0113	70553-0148		
10	70553-0009	70553-0044	70553-0114	70553-0149		
11	70553-0010	70553-0045	70553-0115	70553-0150		
12	70553-0011	70553-0046	70553-0116	70553-0151		
13	70553-0012	70553-0047	70553-0117	70553-0152		
14	70553-0013	70553-0048	70553-0118	70553-0153		
15	70553-0014	70553-0049	70553-0119	70553-0154		
16	70553-0015	70553-0050	70553-0120	70553-0155		
17	70553-0016	70553-0051	70553-0121	70553-0156		
18	70553-0017	70553-0052	70553-0122	70553-0157		
19	70553-0018	70553-0053	70553-0123	70553-0158		
20	70553-0019	70553-0054	70553-0124	70553-0159		
21	70553-0020	70553-0055	70553-0125	70553-0160		
22	70553-0021	70553-0056	70553-0126	70553-0161		
23	70553-0022	70553-0057	70553-0127	70553-0162		
24	70553-0023	70553-0058	70553-0128	70553-0163		
25	70553-0024	70553-0059	70553-0129	70553-0164		

X IN COLUMN UNDER *ASSEMBLY ITEM NUMBER * HEADING DENOTES TOOLING NOT AVAILABLE

UPDATE REV LEVEL EC NO: UCP2010-0787 DRWINSI BARRA 2009/09/24 CHKD:MORGAN 2009/10/02 APPR:SMILLER 2009/10/05	QUALITY SYMBOLS 	GENERAL TOLERANCES (UNLESS SPECIFIED)		DIMENSION STYLE MM/IN		SCALE 4:1	DESIGN UNITS INCH	THIRD ANGLE PROJECTION												
		<table border="1"> <tr><th>mm</th><th>INCH</th></tr> <tr><td>4 PLACES ± .005</td><td>± .005</td></tr> <tr><td>3 PLACES ± .010</td><td>± .010</td></tr> <tr><td>2 PLACES ± .015</td><td>± .015</td></tr> <tr><td>1 PLACE ± .025</td><td>± .025</td></tr> </table>		mm	INCH	4 PLACES ± .005	± .005	3 PLACES ± .010	± .010	2 PLACES ± .015	± .015	1 PLACE ± .025	± .025	DRAWN BY AAB		DATE 1993/05/13	SALES ASSY, SL RIGHT ANGLE HDR W/LATCH (2.54) .100 CENTERS			
		mm	INCH																	
		4 PLACES ± .005	± .005																	
3 PLACES ± .010	± .010																			
2 PLACES ± .015	± .015																			
1 PLACE ± .025	± .025																			
ANGULAR ± 1/2°		CHECKED BY AAB		DATE 1993/05/13																
DRAFT WHERE APPLICABLE MUST REMAIN WITHIN DIMENSIONS		APPROVED BY WAZ		DATE 1993/05/13	MOLEX INCORPORATED		MATERIAL NO. SEE TABLE		SHEET NO. 2 OF 3											
THIS DRAWING CONTAINS INFORMATION THAT IS PROPRIETARY TO MOLEX INCORPORATED AND SHOULD NOT BE USED WITHOUT WRITTEN PERMISSION																				

